

SATATYA CIBR20FL36CWS

2MP IR Bullet Camera with 3.6mm Lens



SATATYA CIBR20FL36CWS
2MP IR Bullet Camera with 2.8mm Lens

Matrix Project Series IP Cameras are built using superior components such as Sony STARVIS sensor and higher MTF lens to offer unmatched image quality especially during the low light conditions. Powered by True WDR algorithm, these cameras offer consistent image quality even in highly varying lighting conditions. Built in intelligent analytics including Intrusion Detection, Trip Wire, etc. ensure real-time security. Moreover, H.265 compression and Automatic Motion based Frame Rate Reduction save bandwidth and storage up to 50%.

USP



SONY STARVIS
SENSOR



H.265
COMPRESSION



IVA



HIGHER FIELD
OF VIEW



SMART
STREAMING



ADAPTIVE
STREAMING



TRUE WDR



NAS

CERTIFICATION



SATATYA CIBR20FL36CWS

2MP IR Bullet Camera with 3.6mm Lens



TECHNICAL SPECIFICATIONS	
IMAGE SENSOR	
Resolution	2 MP (1920 x 1080)
Sensor Type and Size	1/2.8" SONY - CMOS 2MP Active Pixel Progressive Scan, Back Illuminated Image sensor (STARVIS Series)
LENS	
Minimum Illumination	Color - 0.01 Lux @F1.2 (AGC ON) Monochrome - 0 Lux
Focal Length	3.6mm
Focus Range	0.3m to infinity
Field of View (FOV)	HFOV – 87.5° VFOV – 44.4° DFOV – 104.9°
Lens Mount	M12
Focus	Fixed focus
Aperture (F#)	F 1.6
Iris Type	Fixed
IR Range	Up to 50m
IR Led Wavelength	850nm
IR Switching	Auto/ Manual
HARDWARE SPECIFICATIONS	
SD Card	Up to 512GB
Camera Adjustment Angle	Pan: 0° to 360° Tilt: 0° to 90° Rotate: 0° to 360°
IMAGE AND VIDEO	
No of Stream Profiles	4
Stream Profiles	Profile 1: 1920x1080p(2MP) @30fps (H.265/ H.264) Profile 2: D1 @30fps (H.265/H.264) Profile 3: 1920x1080p(2MP) @5fps (MJPEG) Profile 4: 720p @30fps (H.265/H.264/MJPEG)
Available Resolutions	1920 x 1080, 720p, D1, VGA, 2CIF, CIF
Max Resolution	1920 x 1080
Bitrate	128 kbps-8Mbps
Bitrate Type	CBR, VBR
Video Compression	H.265, H.264, MJPEG
Frame Rate	1-30fps
Shutter Speed	1/15s -1/100000s

SATATYA CIBR20FL36CWS

2MP IR Bullet Camera with 3.6mm Lens



Adaptive Streaming	Yes
ONVIF Profiles	Both S and G
Edge Recording	Yes
Alarm Recording	Pre and Post
Motion Recording	Yes
Time Triggered	Yes
Video Parameters	Snapshot, Region of Interest (ROI), BLC, Day/Night Settings
Privacy Masks	8
WDR	True WDR (120dB)
SNR	71dB
Image Enhancement	Rotation/ Saturation/ Contrast/ Sharpness/ Brightness/ Hue/ White Balance
DNR	2D &3D
Video Analytics	Motion/No Motion Detection, Tamper Detection, Trip/No Trip Detection, Object Intrusion/Zone Intrusion
ALERTS	
IP Conflict	Yes
Network Disconnect	Yes
Storage Full	Yes
EVENTS AND ACTIONS	
Upload Image	SD, NAS, FTP
Upload Clip	SD, NAS, FTP
Notifications	E-mail, SMS, TCP
PROTOCOLS SUPPORTED	
Supported protocols	TCP/IP, HTTP, ARP, DSCP, QoS, DHCP, DNS, DDNS, RTP, RTCP, RTSP, PPPOE, SMTP, NTP, HTTPS, TLS/SSL, FTP, ICMP, IGMP, 802.1x, SNMP, UPnP, Bonjour
Web Viewer	Supported in IE 8.0-11.0, Firefox 15.0-47.0, Chrome 20.0-54.0
Browser	IE, Chrome, Mozilla
OPERATING PARAMETERS	
Power Supply	12V (DC); 802.3af (PoE)
Power Consumption	Approximately 7W
Operating Humidity	Less than 90% RH (non-condensing)
Operating Temperature	-30°C to 60°C
Storage Temperature	-30°C to 60°C

SATATYA CIBR20FL36CWS

2MP IR Bullet Camera with 3.6mm Lens



PHYSICAL PARAMETERS	
Communication interface	10Base-T/100BaseTX Ethernet (RJ-45)
Weight	840gms
Color	Infinity White
Dimensions	Φ302mm x 93mm x 85mm (Length x Width x Height)
Storage	NAS, SD Card
Certifications	BIS, CE, IP66, FCC Part-15 Subpart – B, ONVIF S & G

**Specifications are subject to change without prior notice*

DIMENSIONS (in mm)

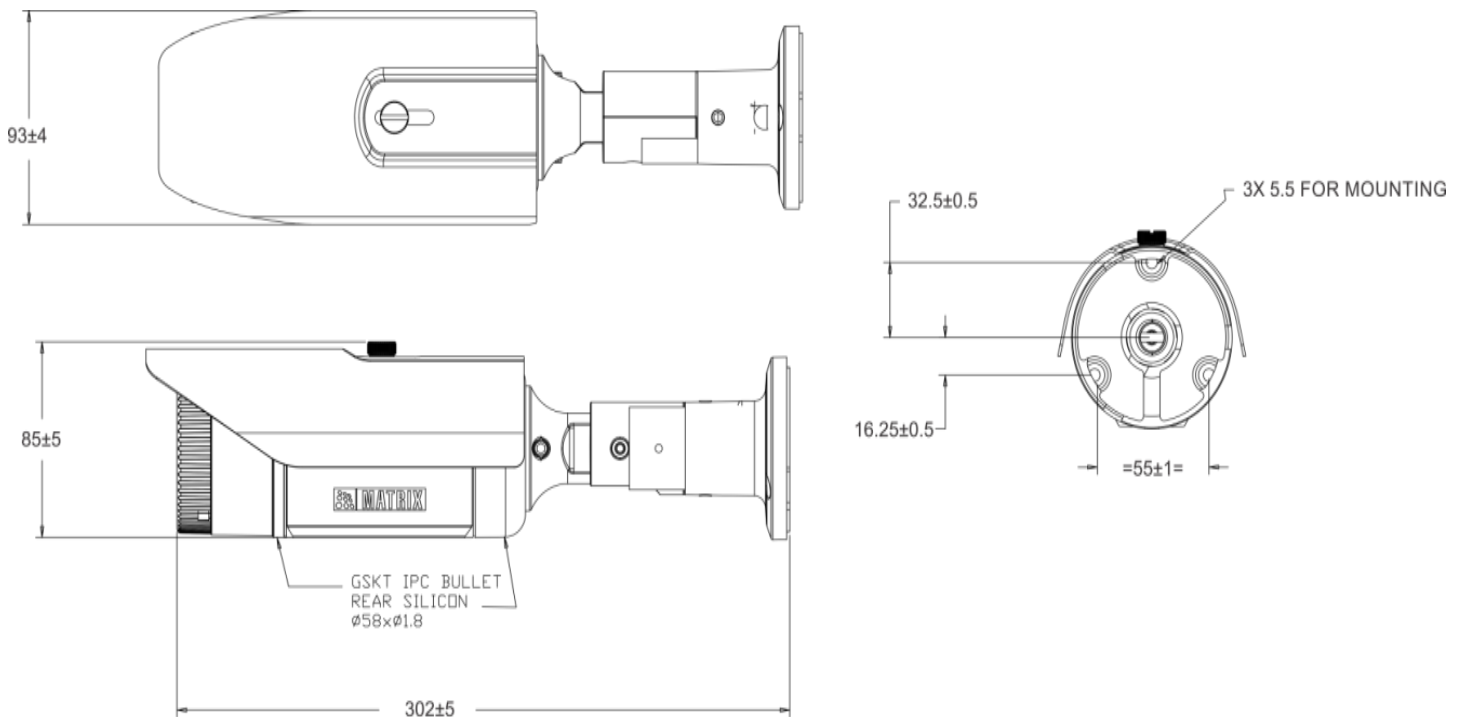

SATATYA CIBR20FL36CWS

2MP IR Bullet Camera with 3.6mm Lens



ABOUT MATRIX

Established in 1991, Matrix is a leader in security and telecom solutions for modern businesses and enterprises. Matrix, an innovative, technology driven and customer focused organization, is committed to keep pace with the revolutions in security and telecom industries. With more than 40% of its human resources dedicated to the development of new products, Matrix has launched cutting-edge products such as Unified Communications, IP-PBX, Universal Gateways, Convergence, VOIP Gateways, GSM Gateways, IP Video Surveillance, Access Control and Time-Attendance. These solutions are feature-rich, reliable and conform to the international standards. Having global footprints in Europe, North America, South America, Africa and Asia through an extensive network of more than 1000 system integrators, Matrix ensures that the products serve the needs of its customers faster and longer. Matrix has gained trust and admiration of customers representing the entire spectrum of industries. Matrix has won many national and international awards for its innovative products.



MATRIX COMSEC

Head Office

394-GIDC, Makarpura,

Vadodara – 390 010, India.

Ph: +91 265 613 7222

E-mail: Inquiry@MatrixComSec.com

Factory

19 – GIDC, Waghodia,

Dist. Vadodara – 391 760, India.

Ph: +91 265 613 7222

MATRIX COMSEC – North America

2 Wickstead Crt,

Brampton,

Ontario, L6R 1N8.

Ph: (+1) 408-643-0581 (USA)

Ph: (+1) 437-266-1005 (Canada)

www.MatrixVideoSurveillance.com